

MSR-CA-WX12M-XK-A1 V1.0

12MP Sony IMX378 MIPI介面 固定焦距 網路攝影機模組



正視圖



後視圖

規格

相機模組編號	MSR-CA-WX12M-XK-A1 V1.0
分辨率	12MP
影像感測器	IMX378
感測器類型	1/2.3"
像素大小	1.55 um x 1.55 um
EFL	6.28 mm
F.NO	2.20
像素	3840 x 2160
視角	128.0°(DFOV) 111.0°(HFOV) 92.1°(VFOV)
鏡頭尺寸	10.80 x 10.80 x 7.10 mm
模組尺寸	112.50 x 12.00 mm
模組類型	固定焦距
介面	MIPI
自動對焦VCM驅動IC	沒有任何
鏡頭類型	650nm 紅外線截止
工作溫度	-20°C to +70°C
配合連接器	AXE530127D

MSR-CA-WX12M-XK-A1 V1.0
12MP Sony IMX378 MIPI介面 固定焦距 網路攝影機模組



頂視圖



側面圖



底視圖

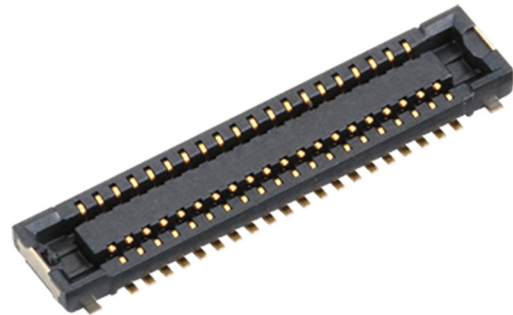

配合連接器

ROHS

PIN	SIGNAL
1	LED+
2	NC
3	LED-
4	DGND
5	NC
6	DOVDD
7	SDA
8	SCL
9	NC
10	RESET
11	DVDD
12	AVDD
13	AGND
14	MCLK
15	DGND
16	DGND
17	MDP0
18	MDN0
19	DGND
20	MDP1
21	MDN1
22	DGND
23	MDP2
24	MDN2
25	DGND
26	MCP
27	MCN
28	DGND
29	MDP3
30	MDN3

3840



Version	Mark	Information	Date
V1.2	PD	镜头更新	2023-11-9
V1.1	PD	LED位置修改	2023-09-22
V1.0	PD	First Version	2023-06-25

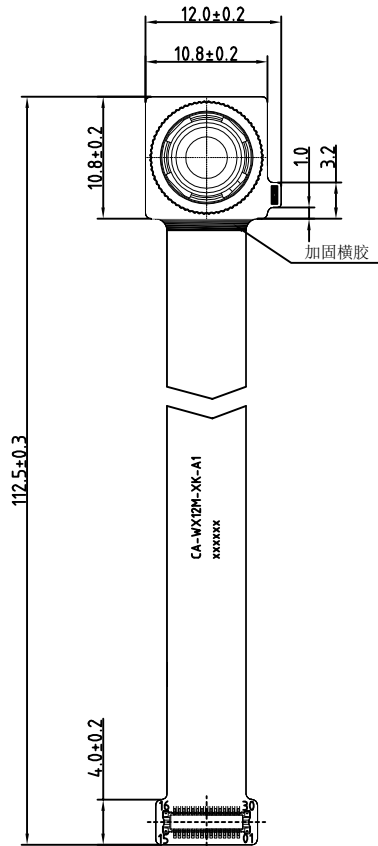

TOP VIEW

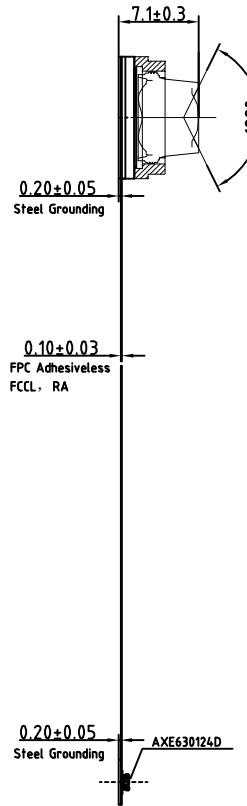

SIDE VIEW

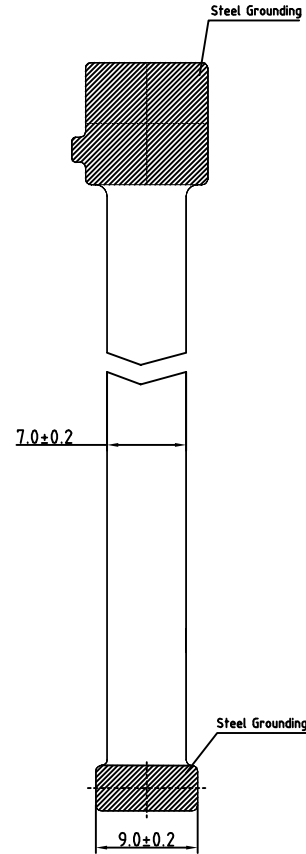

BOTTEM VIEW

Parameters:

1、Sensor specification:

Image Sensor: IMX378
Pixel: 1.55um×1.55um
Lens Type: 1/2.3

2、Lens specification:

FOV: D:128°,H:111°,V:92.1°
F/NO.: 2.2
TV distortion: 7%
TTL: 6.28mm
Composition: 7P

www.MicroStarCam.com

Designed By	Kevin	Model Name:	CA-WX12M-XK-A1		
Checked By	Aouly Yan	Projection Type:	Unit:	Material: -----	
		Third Angle	mm	Scale:	Sheet:
			1:1	1 of 1	1/0

Diagonal 7.857 mm (Type 1/2.3) 12.3Mega-Pixel CMOS Image Sensor with Square Pixel for Color Cameras

IMX378-AAQH5-C

General description and application

IMX378-AAQH5-C is a diagonal 7.857mm (Type 1/2.3) 12.3 Mega-pixel CMOS active pixel type stacked image sensor with a square pixel array. It adopts Exmor RS™ technology to achieve high speed image capturing by column parallel A/D converter circuits and high sensitivity and low noise image (comparing with conventional CMOS image sensor) through the backside illuminated imaging pixel structure. R, G, and B pigment primary color mosaic filter is employed. By introducing spatially multiplexed exposure technology, high dynamic range still pictures and movies are achievable. It equips an electronic shutter with variable integration time. It operates with three power supply voltages: analog 2.8 V, digital 1.05 V and 1.8 V for input/output interface and achieves low power consumption. In addition, this product is designed for use in cellular phone and tablet pc. When using this for another application, Sony does not guarantee the quality and reliability of product. Therefore, don't use this for applications other than cellular phone and tablet pc. Consult your Sony sales representative if you have any questions.

Functions and Features

- ◆ Back-illuminated and stacked CMOS image sensor Exmor RS™
- ◆ Phase Detection Auto Focus(PDAF)
- ◆ Spatially Multiplexed Exposure High Dynamic Range (SME-HDR) mode with raw data output.
- ◆ High signal to noise ratio (SNR).
- ◆ Full resolution@60fps(Normal/SME-HDR) 4K2K @60fps(Normal/SME-HDR) 1080p @240fps Full resolution @40fps(12bit Normal)
- ◆ Output video format of RAW12/10/8, COMP8.
- ◆ Power Save Mode
- ◆ Pixel binning readout and V sub-sampling function.
- ◆ Independent flipping and mirroring.
- ◆ CSI-2 serial data output (MIPI 2lane/4lane, Max. 2.1Gbps/lane, D-PHY spec. ver. 1.2 compliant)
- ◆ 2-wire serial communication.
- ◆ Two PLLs for independent clock generation for pixel control and data output interface.
- ◆ Dynamic Defect Pixel Correction.
- ◆ Fast mode transition. (on the fly)
- ◆ Dual sensor synchronization operation.
- ◆ 7K bit of OTP ROM for users.
- ◆ Built-in temperature sensor
- ◆ 10-bit/12-bit A/D conversion on chip

Exmor RS

Sony reserves the right to change products and specifications without prior notice.

This information does not convey any license by any implication or otherwise under any patents or other right.

Application circuits shown, if any, are typical examples illustrating the operation of the devices. Sony cannot assume responsibility for any problems arising out of the use of these circuits.

Device Structure

- ◆ CMOS image sensor
- ◆ Image size : Diagonal 7.857 mm (Type 1/2.3)
- ◆ Total number of pixels : 4072 (H) × 3176 (V) approx. 12.93 M pixels
- ◆ Number of effective pixels : 4072 (H) × 3064 (V) approx. 12.47 M pixels
- ◆ Number of active pixels : 4056 (H) × 3040 (V) approx. 12.33 M pixels
- ◆ Chip size : 7.564 mm (H) × 5.476 mm (V)
- ◆ Unit cell size : 1.55 μm (H) × 1.55 μm (V)
- ◆ Substrate material : Silicon

Absolute Maximum Ratings

Item	Symbol	Ratings	Unit	notes
Supply voltage (analog)	VANA	-0.3 to +3.3	V	refer to VSS level
Supply voltage (digital)	VDIG	-0.3 to +1.8	V	
Supply voltage (interface)	VIF	-0.3 to +3.3	V	
Input voltage (digital)	VI	-0.3 to +3.3	V	
Output voltage (digital)	VO	-0.3 to +3.3	V	
Guaranteed Operating temperature	TOPR	-20 to +70	°C	
Guaranteed storage temperature	TSTG	-30 to +80	°C	
Guaranteed performance temperature	TSPEC	-20 to +60	°C	

Recommended Operating Voltage

Item	Symbol	Ratings	Unit	notes
Supply voltage (analog)	VANA	2.8 ± 0.1	V	refer to VSS level
Supply voltage (digital)	VDIG	1.05 ± 0.1	V	
Supply voltage (interface)	VIF	1.8 ± 0.1	V	

相機應用



汽車駕駛員飛行員



直播



視訊會議



眼動儀生物辨識檢測

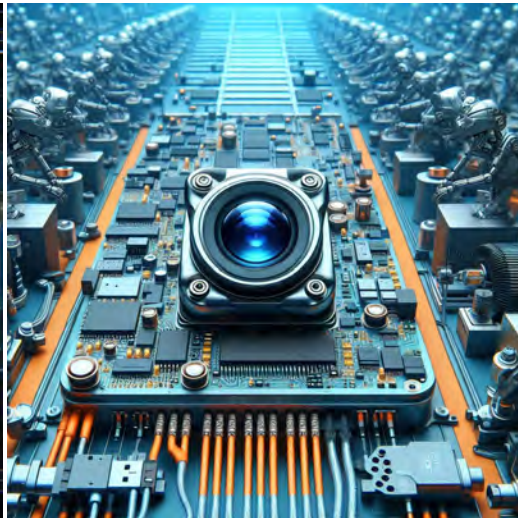

機器視覺



農業監測儀



夜視安全



無人機和運動鷹眼



互動寵物相機

相機模組引腳定義參考圖

OmniVision Sony Himax Samsung On-Semi Aptina Himax GalaxyCore PixArt SmartSens 影像感測器	
引腳訊號	描述
DGND GND	數位電路接地
AGND	模擬電路接地
PCLK DCK	DVP PCLK 輸出
XCLR PWDN XSHUTDOWN STANDBY	斷電高電平有效，內帶下拉電阻
MCLK XVCLK XCLK INCK	系統輸入時鐘
RESET RST	透過內部上拉電阻復位低電平有效
NC NULL	沒有連接
SDA SIO_D SIOD	SCCB數據
SCL SIO_C SOIC	SCCB 輸入時鐘
VSYNC XVS FSYNC	DVP 垂直同步輸出
HREF XHS	DVP HREF 輸出
DOVDD	I/O電路電源
AFVDD	VCM電路電源
AVDD	模擬電路電源
DVDD	數位電路電源
STROBE FSTROBE	選通輸出
FSIN	同步來自其他感測器的 VSYNC 訊號
SID	SCCB 最後一位 ID 輸入
ILPWM	機械快門輸出指示燈
FREX	影格曝光/機械快門
GPIO	通用輸入
SLASEL	I2C從機位址選擇
AFEN	CEN 晶片在 VCM 驅動器 IC 上啟用高電平有效
MIPI介面	
MDN0 DN0 MD0N DATA_N DMO1N	MIPI 第一數據通道負輸出
MDP0 DP0 MD0P DATA_P DMO1P	MIPI 第一數據通道正輸出
MDN1 DN1 MD1N DATA2_N DMO2N	MIPI 第二數據通道負輸出
MDP1 DP1 MD1P DATA2_P DMO2P	MIPI 第二數據通道正輸出
MDN2 DN2 MD2N DATA3_N DMO3N	MIPI 第三數據通道負輸出
MDP2 DP2 MD2P DATA3_P DMO3P	MIPI 第三數據通道正輸出
MDN3 DN3 MD3N DATA4_N DMO4N	MIPI 第四數據通道負輸出
MDP3 DP3 MD3P DATA4_P DMO4P	MIPI 第四數據通道正輸出
MCN CLK_N DCKN	MIPI時脈負輸出
MCP CLK_P DCKN	MIPI時脈正輸出
DVP並行介面	
D0 DO0 Y0	DVP數據輸出口0
D1 DO1 Y1	DVP數據輸出口1
D2 DO2 Y2	DVP數據輸出口2
D3 DO3 Y3	DVP數據輸出口3
D4 DO4 Y4	DVP數據輸出口4
D5 DO5 Y5	DVP數據輸出口5
D6 DO6 Y6	DVP數據輸出口6
D7 DO7 Y7	DVP數據輸出口7
D8 DO8 Y8	DVP數據輸出口8
D9 DO9 Y9	DVP數據輸出口9
D10 DO10 Y10	DVP數據輸出口10
D11 DO11 Y11	DVP數據輸出口11

相機可靠性測試

可靠度檢驗項目		物品	測試方法	驗收標準
類別				
環境性能	貯存溫度	高溫60°C 96小時	恆溫箱	無異常狀況
		低溫-20°C 96小時	恆溫箱	無異常狀況
	工作溫度	高溫60°C 24小時	恆溫箱	無異常狀況
		低溫-20°C 24小時	恆溫箱	無異常狀況
	濕度	60°C 80% 24 小時	恆溫箱	無異常狀況
	熱衝擊	高溫60°C 0.5小時 低溫-20°C 0.5小時 24小時運行	恆溫箱	無異常狀況
物理性能	跌落測試 (自由下落)	不含包裝60cm	在木地板上 10 次	電氣功能正常
		含包裝60cm	在木地板上 10 次	電氣功能正常
	振動測試	50Hz X軸2mm 30分鐘	振動台	電氣功能正常
		50Hz Y軸2mm 30分鐘	振動台	電氣功能正常
		50Hz Z軸2mm 30分鐘	振動台	電氣功能正常
	電纜拉伸 強度測試	負載重量 4 公斤 60秒 24小時運行	拉力試驗機	電氣功能正常
電氣性能	靜電放電測試	接觸放電2KV	靜電放電測試機	電氣功能正常
		空氣放電4KV	靜電放電測試機	電氣功能正常
	老化測試	開/關 30 秒 24小時運行	電源開關	電氣功能正常
	USB連接器	開/關250次	插拔	電氣功能正常



相機檢驗標準

檢查項目		檢驗方法	檢驗標準	
類別	物品			
外貌	FPC / PCB	顏色	肉眼	不允許出現重大差異。
		損壞	肉眼	不允許出現銅裂紋暴露。
		標記	肉眼	清晰可辨 (30cm距離內)
	底座	刮痕	肉眼	內部裂縫不允許外露
		裂縫	肉眼	內部裂縫不允許外露
		螺絲	肉眼	確保提供螺絲 (如果有)
		損壞	肉眼	內部裂縫不允許外露
	鏡頭	刮痕	肉眼	對分辨率標準沒有影響
		污染	肉眼	對分辨率標準沒有影響
		油膜	肉眼	對分辨率標準沒有影響
		蓋膠帶	肉眼	外觀沒有問題。
	功能	影像	沒有通訊	測試板
亮像素			黑板	不允許進入影像中心
暗像素			白板	不允許進入影像中心
模糊			肉眼	不允許
沒有影像			肉眼	不允許
垂線			肉眼	不允許
水平線			肉眼	不允許
漏光			肉眼	不允許
閃爍影像			肉眼	不允許
挫傷			檢驗治具	不允許
解析度			圖表	遵循出廠檢驗圖標準
顏色			肉眼	沒有任何問題
噪音		肉眼	不允許	
角落黑暗		肉眼	小於 100 像素 × 100 像素	
色彩解析度		肉眼	沒有任何問題	
尺寸規格	高度	肉眼	遵循核准數據表	
	寬度	肉眼	遵循核准數據表	
	長度	肉眼	遵循核准數據表	
	全面的	肉眼	遵循核准數據表	

YDS (MICROSTAR) 封裝解決方案

YDS (微星) 相機模組



附鏡頭保護膜



帶有網格和空間的托盤



將相機放在托盤上

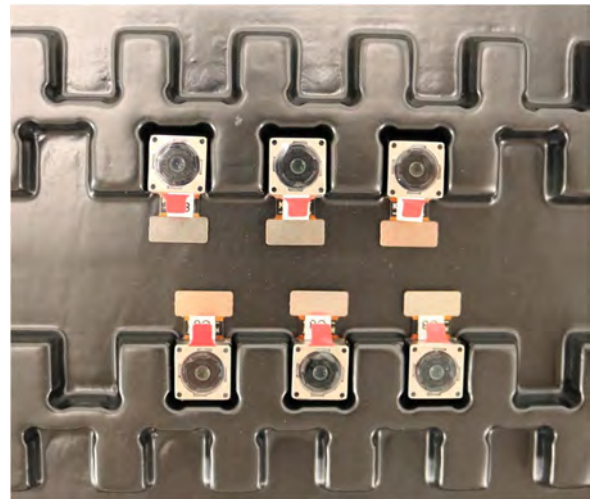

YDS (MICROSTAR) 封裝解決方案

滿托盤的相機

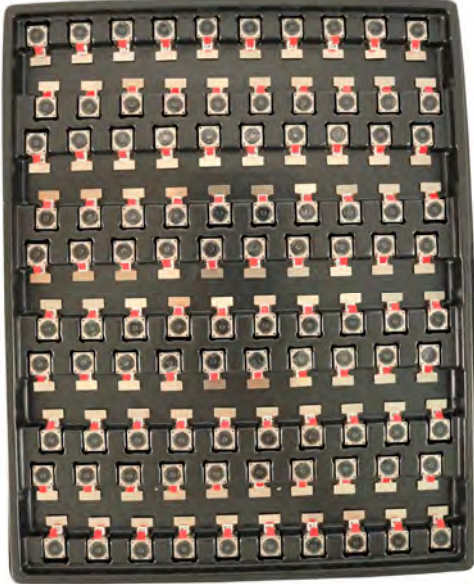

用蓋子蓋住托盤

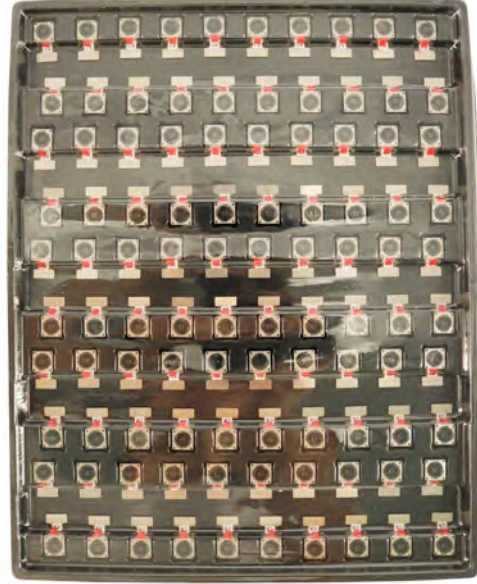

將托盤放入防靜電袋中



將防靜電袋進行抽真空



YDS (MICROSTAR) 封裝解決方案

帶標籤的密封防靜電真空袋

1. 型號與描述 2. 數量 3. 製造日期代碼 4. 注意



YDS (MICROSTAR) 封裝解決方案

將泡棉板放在托盤袋之間



泡棉板比托盤大



將泡棉板和托盤放入盒子中



泡棉板與盒子緊密貼合



密封外箱



最終包裝貼有標籤的外箱



YDS (MICROSTAR) 封裝解決方案

USB相機模組

附鏡頭保護膜

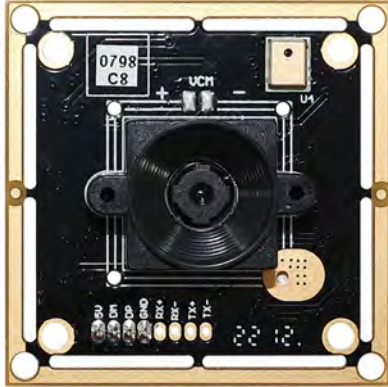

將相機樣品放入防靜電袋中

將 USB 攝影機放置在隔間中



用防靜電袋密封托盤

在運輸箱上貼上標籤



YDS (MICROSTAR) 封裝解決方案

將相機樣品放入防靜電袋中



將連接器放入防靜電袋中



給樣品袋貼上標籤



將連接器插入線輪圈



將樣品放入運輸箱



將連接器放入運輸箱



關於我們公司 YingDeShun Co. Ltd. 盈德順有限公司 (微星品牌 Micro Star Brand)

盈德順有限公司 YingDeShun Co. Ltd. (YDS) 成立於2017年，是一家專業從事影音產品研究、設計和生產的新一代技術驅動型製造商。

「微星」Micro Star 是YDS旗下的品牌產品。我們的工廠擁有 50,000 平方英尺的自動化工廠，擁有 200 名員工，年產量為 85,000,000 台攝影機。

「微星」Micro Star (YDS) 提供 OEM、ODM 設計、合約製造和製造相機產品。您可以向我們提供需求，即使只有手稿，我們的銷售和工程人員也會共同滿足您的需求。我們認為Micro Star (YDS) 是您開發實用和創新解決方案的長期合作夥伴。

我們的團隊涵蓋從最初的概念開發到大量生產的產品的各個方面。「微星」Micro Star (YDS) 科技專注於客製化相機設計、原材料、電子工程、韌體/軟體開發、產品測試和包裝設計。我們經驗豐富的策略供應系統為各種規模的訂單提供強大而可靠的製造能力。

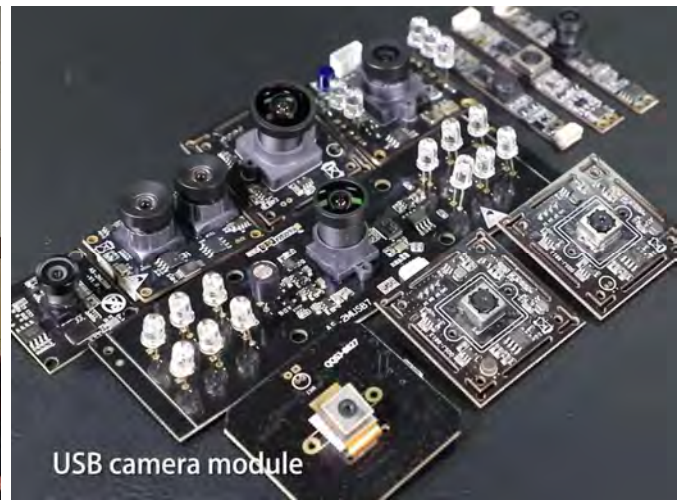

有限保固

如果您直接從 YDS 公司或微星網站 www.MicroStarCam.com 購買產品，微星 Micro Star (YDS) 提供以下有限保固。從其他賣家或來源購買的產品不在本有限保固範圍內。微星 Micro Star 保證產品在正常使用情況下自您收到產品之日起一 (1) 年內 (「保固期」) 不存在材料和工藝缺陷。

對於在保固期內包含或出現材料或工藝重大缺陷的所有產品，微星 Micro Star 將自行選擇：(i) 修理產品；(ii) 將產品更換為新產品或翻新產品 (更換產品具有相同型號或同等功能)；(iii) 向您退還您購買產品時所支付的費用。

微星 Micro Star 的有限保固僅限於根據上述條款進行維修和/或更換。微星 Micro Star 對任何後續事件不可靠也不負任何責任。



我們的公司實力

實力工廠



專業服務



承諾交貨

